

Installation & Instructions Manual

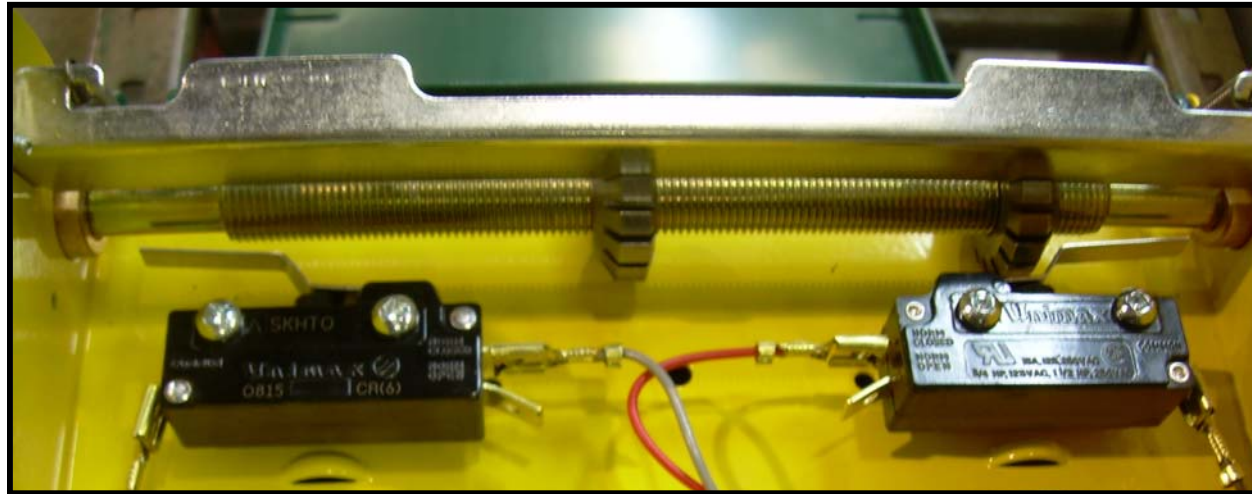

Field modification of limit system
(Operator built with ECB, Opera series)



IMPORTANT

Before starting any intervention, please check if you have the right tools and all the parts needed.

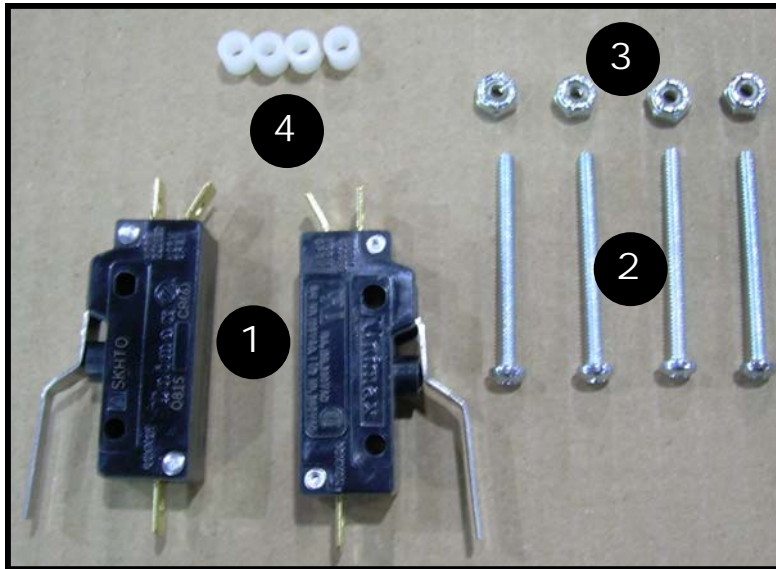

PROVIDED PARTS

Check if the kit include all the following parts

| No. | Qty | Parts no. | Descriptions |
|-----|-----|-----------|----------------------------|
| 1 | 2 | LIMIT022 | Single limit switch |
| 2 | 4 | SCREW097 | 6-32 X 1-5/8 Machine screw |
| 3 | 4 | NUT018 | 6-32 Hex Nylon Lock nuts |
| 4 | 4 | SPACER001 | Limit Switch Spacer |

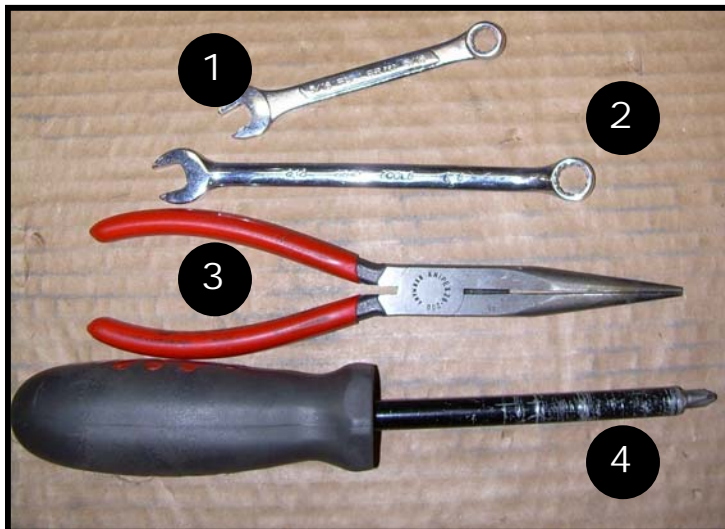

REQUIRED TOOLS (For modification)

| No. | Qty | Tools description |
|-----|-----|-----------------------------------|
| 1 | 1 | 5/16 wrench (combined fork + eye) |
| 2 | 1 | 3/8 wrench (combined fork + eye) |
| 3 | 1 | Long nose pliers |
| 4 | 1 | Phillips No2 screw driver |

Step 1: Remove the existing limit system from the control box



WARNING

Before starting any intervention, please shut OFF the main power from the operator or the control panel

1. Open the control box cover.
2. Disconnect the wires from « Open & Close » limit switches (if required mark the wires before disconnecting them) .
3. Unscrew the centre holding nut and take-out the LEVER070 (use Philipps screw driver and 3/8 wrench)
4. Use the Philipps screwdriver and 5/16 wrench to take-out the « Open & Close » limit switches.

NOTE: The removed parts will no longer be required.

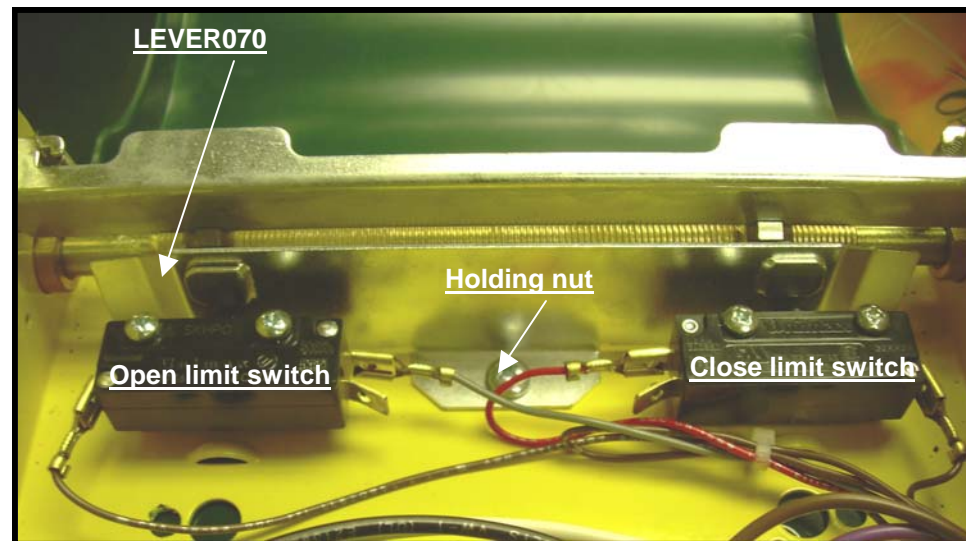

Shown existing limit system in an Opera series control box.

Step 2: Installing the new limit system in the control box

Location of the limit switches mounting holes in the control box



Opera series control box shown

Preassembly of limit switches (Limit + screw + spacer)

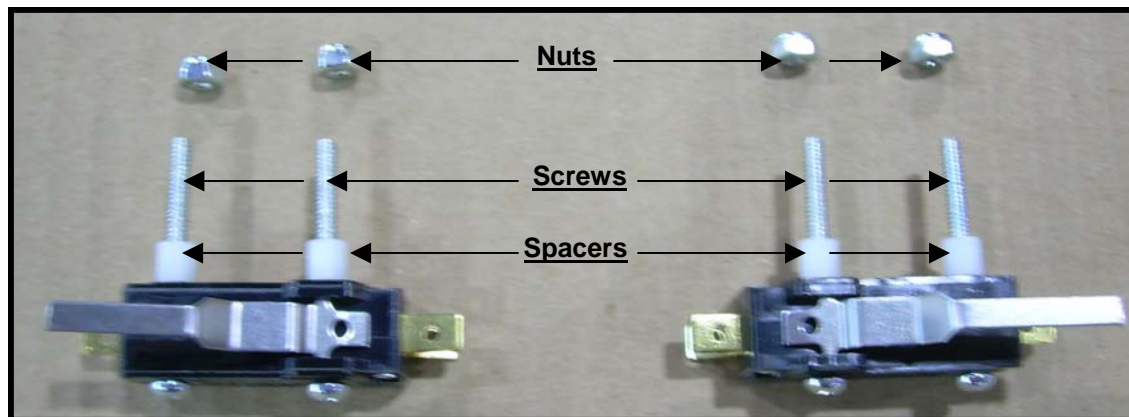

Open limit switch

Close limit switch

Step 3: Mounting of new limit system in the control box

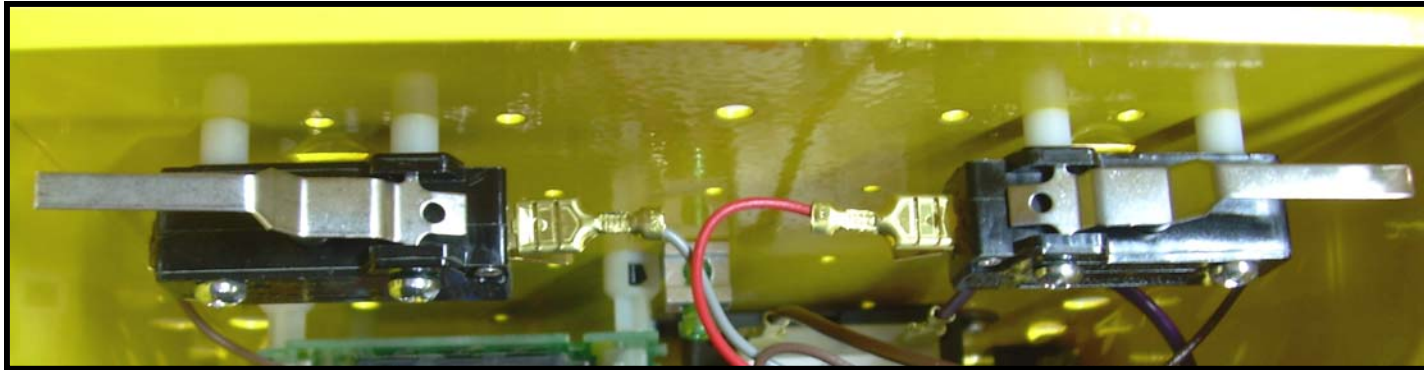

Open limit switch

Close limit switch

Mount the preassembled limit switches to the respective mounting holes, use the screwdriver and 3/16 wrench to tight the new limit system to the control box

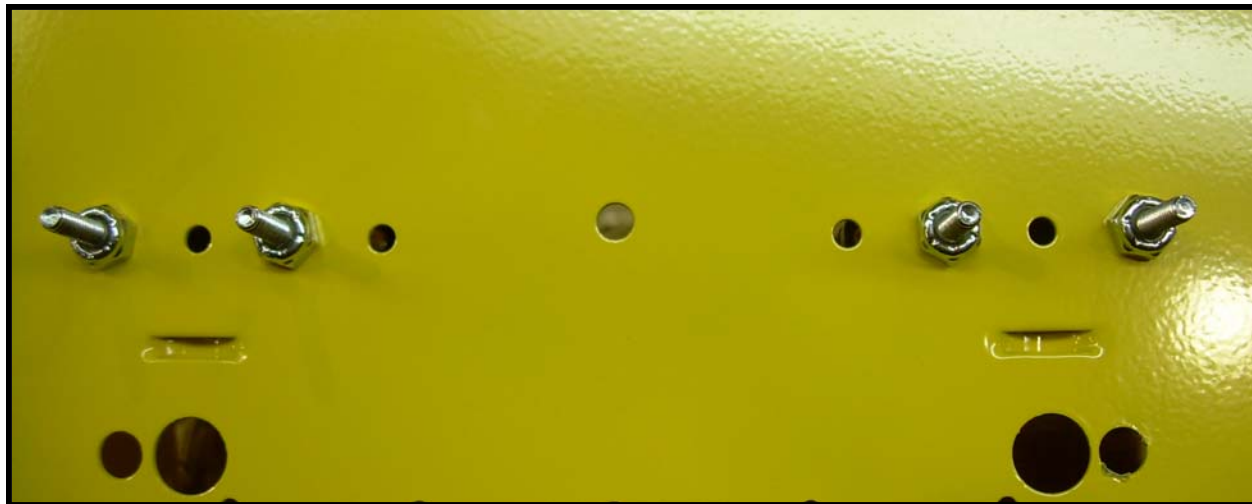

Back face of the control box

Step 4:

1. Reconnecting of wires and limit adjustment.

New limit system

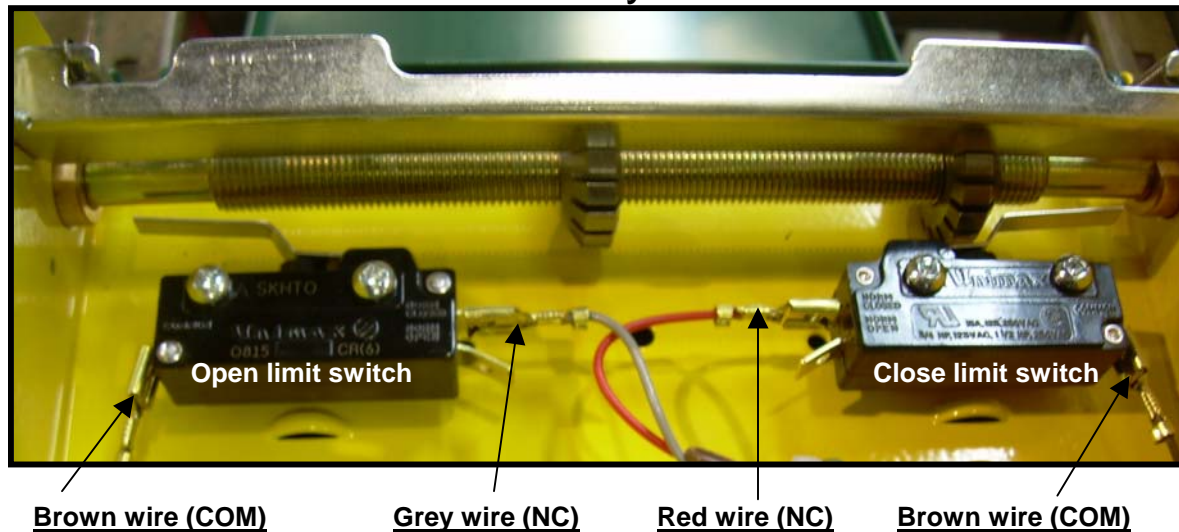

2. Limit switches adjustment.

Note: This unit is provided with ACCU-CAM® for precise and quick one-handed adjustment feature.

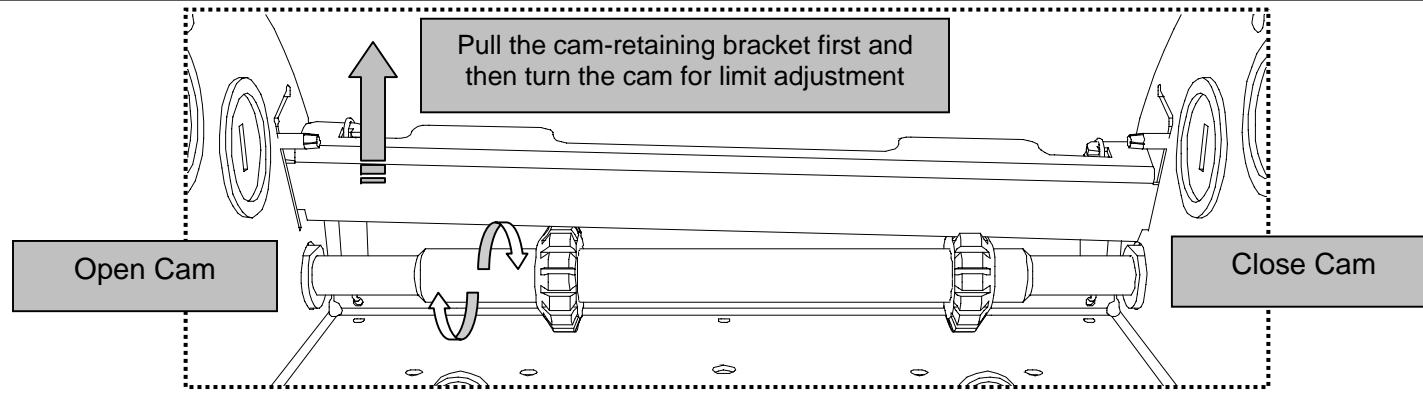

Note: Turning the cam towards the center on the limit shaft increases door travel.
Turning the cam towards the limit switch decreases door travel.

- Open limit switch adjustment:

1. Manually raise the door to a nearly opened or desired open position.
2. Pull the cams-retaining bracket from the Open side and rotate manually the Open cam until the cam activates the Open limit switch sufficiently so as to hear the switch click and the "OPEN LIMIT" light come ON.
3. Release cam-retaining bracket and make sure that the bracket engages in the slots of both cams.

- Close limit switch adjustment:

4. Manually lower the door to a nearly to 6" above the ground.
5. Pull the cams-retaining bracket from the Close side and rotate manually the Close cam until the cam activates the Close limit switch sufficiently so as to hear the switch click and the "CLOSE LIMIT" light come ON

- Testing door electrically:

6. Upon completion of all wiring connections, use the wall push buttons (or on board buttons for ECB), to run the door electrically and check if it is stopping properly to fully open and fully close positions.

- Fine adjustment:

If door is not opening or closing properly or if there is a gap between the door and floor, re-adjust the close limit switch.

Note: One (1) on cam is equal to about ½" on the door travel.

For close position:

Adjust one notch at a time until the close limit switch is properly adjusted and the door stop smoothly on closed position.

For more information or for technical assistance please contact Manaras-Opera at 1-800-361-2260.



Commercial Door OPERATOR



Manaras-Opera is extending their well-known OPERA brand name across its entire line of Commercial Door OPERATORS. Over the years, the OPERA brand name has become synonymous with innovation and reliability. The high quality products you have come to expect from us will now be backed by the OPERA brand name.

When you think Commercial Door OPERATORS, just think OPERA.

Call us for more information:
1-800-361-2260



"Easy to install. Easy to use. Year after year."

www.manaras.com